

ISO6431 Mickey Mouse Profile, Tie Rod Cylinder

SI/ST Series

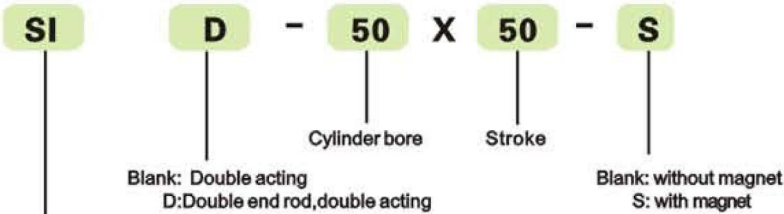

How to Order



SI: Mickey mouse profile type
ST: Tie rod type

Dimensions(mm)

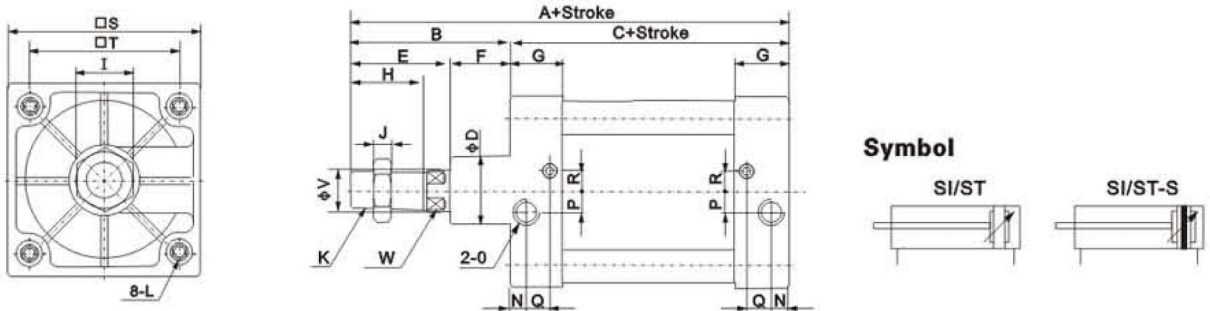

Bore(mm)	A	B	C	D	E	F	G	H	I	J	K	L
32	142	48	94	30	30	18	27.5	22	17	6	M10x1.25	M6
40	159	54	105	35	34	20	32	24	19	7	M12x1.25	M6
50	175	69	106	40	42	27	31	32	24	8	M16x1.5	M8
63	190	69	121	45	40	29	33	32	24	8	M16x1.5	M8
80	214	86	128	45	53	33	33	40	30	10	M20x1.5	M10
100	229	91	138	55	55	36	37	40	30	10	M20x1.5	M10
125	279	119	160	60	74	45	46	54	41	13.5	M27x2	M12
160	332	152	180	65	94	58	50	72	55	18	M36x2	M16
200	347	167	180	75	100	67	50	72	55	18	M36x2	M16

Bore(mm)	N	O	P	Q	R	S	T	V	W
32	13.5	1/8	4	7.5	7	47	32.5	12	10
40	16	1/4	6	9.5	9	53	38	16	13
50	18.5	1/4	8.5	6.7	9	65	46.5	20	17
63	19	3/8	6	7.7	9	75	56.5	20	17
80	19	3/8	10	5	13.5	95	72	25	22
100	18	1/2	12.5	10	14.5	115	89	25	22
125	23	1/2	14	12	14	140	110	32	27
160	25	3/4	15	12	20	180	140	40	36
200	25	3/4	15	12	20	220	175	40	36

SI/ST Cylinder Accessories Mounting Parts

How to Order

SI/ST

50

FA

Series

Cylinder bore

Accessory model

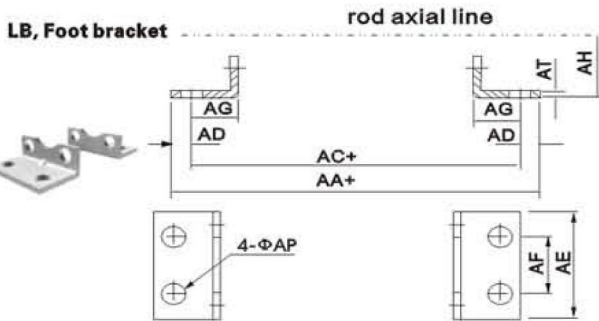

Bore(mm)	32	40	50	63	80	100	125	160	200
AA	158	179	190	209	248	258	290	340	380
AC	142	161	170	185	210	220	250	300	320
AD	8	9	10	12	19	19	20	20	30
AE	48	53	63	73	98	115	140	180	220
AF	32	36	45	50	63	75	90	115	135
AG	24	28	32	32	41	41	45	60	70
AH	32	36	45	50	63	71	90	115	135
AP	7	9	9	9	12	14	16	18	22
AT	5	5	5	5	5	5	8	8	9

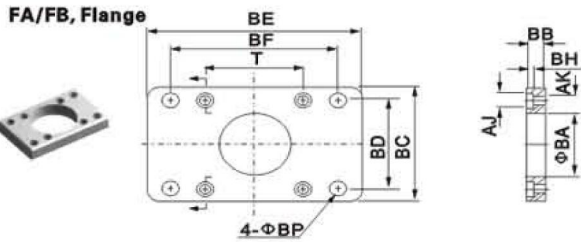

Bore(mm)	32	40	50	63	80	100	125	160	200
AJ	10.5	10.5	10.5	14	17	17	17	20	20
AK	7	7	7	9	10.5	10.5	10.5	12.5	12.5
BA	30.3	35.5	40.3	45.3	45.3	55.3	60.3	65.3	75.3
BB	10	10	12	12	16	16	20	20	25
BC	50	55	65	75	100	120	140	180	220
BD	32	36	45	50	63	75	90	115	135
BE	80	90	110	125	154	186	224	280	320
BF	64	72	90	100	126	150	180	230	270
BH	6.5	6.5	6.5	8.5	10.5	10.5	10.5	12.5	12.5
BP	7	9	9	9	12	14	16	18	22
T	32	36	45	50	63	75	90	115	135

CA, Clevis

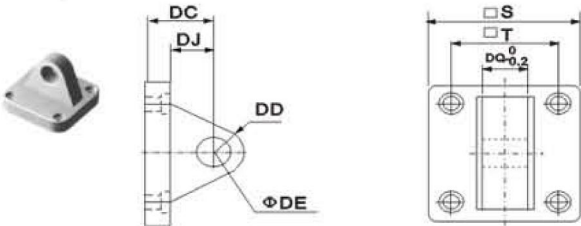

Bore(mm)	32	40	50	63	80	100	125	160	200
S	47	53	65	75	95	115	140	180	220
T	32.5	38	46.5	56.5	72	89	110	140	175
DC	22	25	27	32	36	41	50	55	60
DD	9	12	12	15	15	20	25	30	30
DE	10	12	12	16	16	20	25	30	30
DJ	13	16	17	22	22	27	33	35.5	37
DQ	28.5	27.8	31.7	39.7	49.7	59.7	69.7	89.7	89.7

CB, Clevis

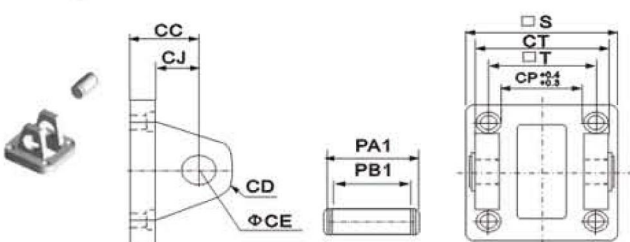

Bore(mm)	32	40	50	63	80	100	125	160	200
CC	22	25	27	32	36	41	50	55	60
CD	5	5	3	3	8	8	8	9	9
CE	10	12	12	16	16	20	25	30	30
CJ	13	16	17	22	22	27	31	35.5	36
CP	26	28	32	40	50	60	70	90	90
CT	45	52	60	70	90	110	130	170	170
PA1	52	60	68	79	99	119	139	181	181
PB1	46.5	53.5	61.5	71.5	91.5	111.5	131.5	171.5	171.5
S	47	53	65	75	95	115	140	180	220
T	32.5	38	46.5	56.5	72	89	110	140	175

SI/ST Series Cylinder Accessories

How to Order

SI/ST - **50** - **Y**

Series

Bore

I:I type

Y: Y Rod clevis

FK: Self aligning rod coupler

SGS: Rod eye

Y Type: Y Rod clevis

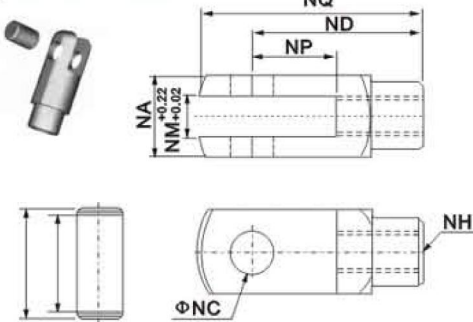

I Type

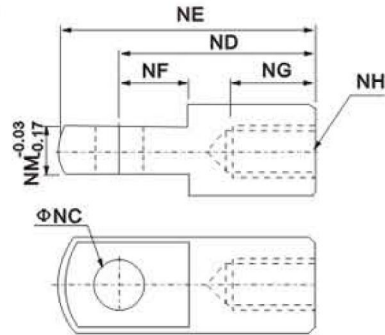

Bore	NA	NC	ND	NE	NG	NH	NM	NP	NQ	PA	PB
32	19	10	40	52	20	M10x1.25	10	20	52	26.2	20
40	25.4	12	48	67	20	M12x1.25	12	24	62	32.8	26.5
50	32	16	64	89	23	M16x1.5	16	32	83	39.3	33
63	32	16	64	89	23	M16x1.5	16	32	83	39.3	33
80	44.4	20	80	112	30	M20x1.5	20	40	105	53.3	45
100	44.4	20	80	112	30	M20x1.5	20	40	105	53.3	45
125	55	30	110	155	56	M27x2.0	30	54	148	64	55.6
160	70	35	144	201	72	M36x2.0	35	72	191	80	70.6
200	70	35	144	201	72	M36x2.0	3	72	191	80	70.6

FK Type: Self aligning rod coupler

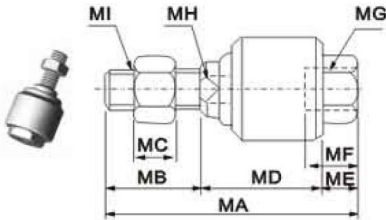

Bore	MA	MB	MC	MD	ME	MF	MG	MH	MI
32	73	20	6	45	8	26	M10x1.25	12	M10x1.25
40	77	24	7	46	7	26	M12x1.25	12	M12x1.25
50	106	32	8	62	12	34	M16x1.5	19	M16x1.5
63	106	32	8	62	12	34	M16x1.5	19	M16x1.5
80	122	40	10	68	14	42	M20x1.5	19	M20x1.5
100	122	40	10	68	14	42	M20x1.5	19	M20x1.5
125	147	54	13.5	77	16	40	M27x2.0	24	M27x2.0
160	251	72	18	161	18	78	M36x2.0	36	M36x2.0
200	251	72	18	161	18	78	M36x2.0	36	M36x2.0

SGS: Rod eye

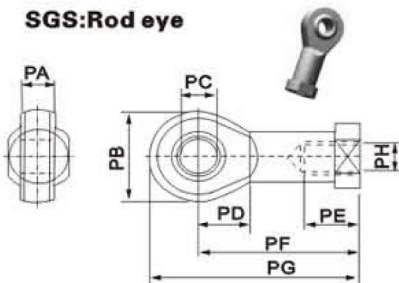

Bore	PA	PB	PC	PD	PE	PF	PG	PH
32	14	28	10	15	20	43	57	M10x1.25
40	16	32	12	17	22	50	66	M12x1.25
50	21	42	16	22	28	64	85	M16x1.5
63	21	42	16	22	28	64	85	M16x1.5
80	25	50	20	26	33	77	102	M20x1.5
100	25	50	20	26	33	77	102	M20x1.5
125	37	70	30	36	51	110	145	M27x2.0
160	43	80	35	41	56	125	165	M36x2.0
200	43	50	35	41	56	125	165	M36x2.0